

NOTES:

1. INSTALLATION TO BE COMPLETED PER MANUFACTURER'S SPECIFICATION.
2. REFER TO TrexFencingFDS.com FOR CONSTRUCTION DETAILS AND PRODUCT INFORMATION
3. DRAWING NOT TO SCALE.

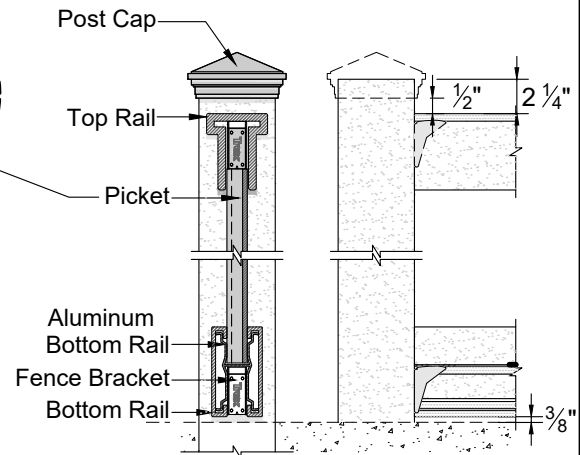
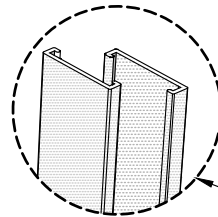

COMPONENT	QTY.	LENGTH	COMPONENT	QTY.	LENGTH
Post Cap 	1	N/A	Bottom Rail / Picket 	2	91"
Post 	.5	144"	Aluminum Bottom Rail 	1	90 1/2"
Top Rail 	1	91"	Fence Bracket 	4	N/A
Picket (Cut to 31 1/2") 	9.5	67"	Ext. Wood Screw 	24	1 5/8"

Component lengths may vary

CUT VIEWS

010923